

FC48XDNE



Product Family	Refrigerator
Installation	Free standing
Category	Bottom Mount
Reference width	60 - 70
Reference height	160 - 200
Sistema Total No - Frost	Yes
Cooling type	No Frost
Defrost	Automatic
Hinge type	Standard
Hinge position	Right
Reversible door	Yes
EAN code	8017709343521



Aesthetics



Colour	Pet Inox Look	Door shelves profile color	Silver
Material	Steel Effect	Drawers profile color	Silver
Handle	Integrated	Color of glass shelf profile	Silver
Logo colour	Silver	Display	LED
Side material	Steel	Display position	Esterno (su porta)
Logo	Silk screen		

Refrigerator compartment features



No. of adjustable shelves	3	Type of crisper/vegetable drawers cover	Glass
Number of fruit and vegetables drawers	1	No. of lights refrigerator compartment	2
Type of adjustable shelves	Glass	Low temperature compartment	Yes
Type of crisper/vegetable drawers cover	Standard	Internal light in fridge	Yes
Crisper Cover	Yes	Type of internal light (fridge)	LED

Refrigerator Inner Door

Number of adjustable door shelves	3	No. of bottle shelves	1
-----------------------------------	---	-----------------------	---

Other Refrigerator features



Accessories	Egg tray	Fan	Yes
--------------------	----------	------------	-----

Freezer compartment features

Number of drawers	2	Type of shelves	Glass
No. of compartments with flap	1		

Other Freezer features



Accessories	manual ice-maker	Ice maker	Manual
Manual ice maker	Yes	Fast freezing compartment	Yes

Other technical features



Functions display	Holiday, Fast freezing, Fast cooling, ECO, Control lock, Cooling timer
Fast freezing button	Yes
Power on lamp	Yes
Door open alarm	Yes
Type of temperature control	Electronic
No. of compressors	1
Refrigerant gas type	R600a
Type of compressor	Inverter
Refrigerant Quantity (gr)	68 g
Foam agent	Cyclopentane

Performance / Energy Label - Reg. 2019



Annual energy consumption	287 kWh/a	Airborne acoustical noise emissions	41 dB(A) re 1 pW
Energy efficiency class	E	Temperature Rise Time	14 h
Airborne acoustical noise emission class	C	4 star - Freezing capacity	8.0 Kg/24h
Total net volume	481 l	Climate class	SN, N, ST, T
Sum of the volumes of the frozen compartment(s)	137 l	EEl	100 %







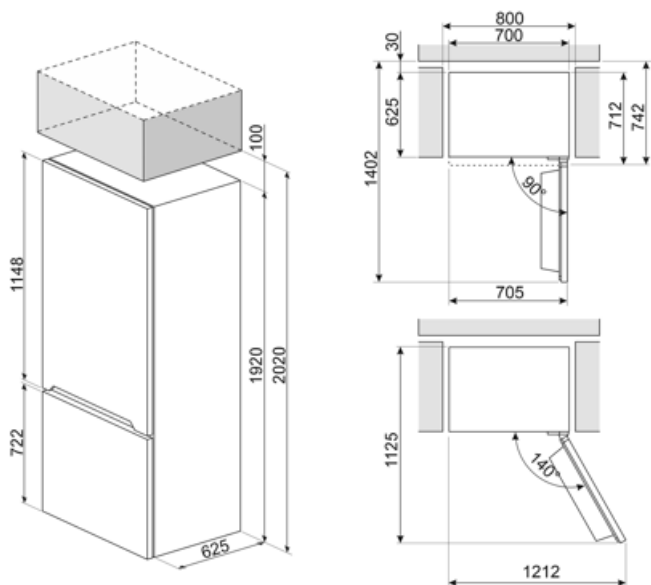



Sum of the volumes of the chill compartment(s) and the unfrozen compartment(s) 344 l

Electrical Connection

Plug	(F;E) Schuko	Voltage (V)	220-240 V
Electrical connection rating	185 W	Frequency (Hz)	50 Hz
Current	1,27 A	Power supply cable length	210 cm



Symbols glossary (TT)

	The automatic defrost system works by automatically defrosting at regular intervals eliminating the need to defrost altogether.		Child lock: some models are fitted with a device to lock the programme/cycle so it cannot be accidentally changed.
	LED display: to show programmes, functions and options selected and the time to the end of the cycle.		Economical mode: Analyzes fridge functioning during the activation and optimizes the operating cycle in order to reduce power consumption.
	Ventilated: Forced distribution of cold air in the refrigerator compartment, which allows even temperature distribution within the fridge.		Fast freezing: The fast freezing function brings the temperature of the compartment down when activated a few hours prior to usage.
	Power saving mode: The power saving mode allows you to disable the refrigerator and keep the freezer working.		LED interior lighting: is a more energy efficient and long lasting way of illuminating the interior of the appliance.
	Smeg's evolution towards more intelligent and eco-friendly models has led to the choice of Inverter technology, which significantly reduces consumption.		No Frost: The No Frost and Frost free systems prevent ice from forming so that no defrosting is required.
	Energy efficiency class E		